

Installing Your 220v J-POD Kit

Hard-wired PumpJump™ on Your D/DX Series Digital HEAT SIPHON®



NOTE: There are two J-POD versions depending on your pump voltage - 110 volt and 220 volt. **MAKE SURE YOU HAVE THE RIGHT VOLTAGE J-POD FOR YOUR PUMP.**

Using software and hardware ALREADY BUILT INTO your DIGITAL D or DX series HEAT SIPHON's PLAYER CONTROL BOARD, your J-POD Accessory Kit adds PUMPJUMP™ off cycle heating to maintain your pool at temperature 24 hours/day - 7 days/week - EVEN WHEN YOUR POOL PUMP TIME CLOCK HAS THE PUMP OFF.

J-POD is designed to enable the "PumpJump™" feature built into your Heat Siphon Player Control to ensure that your pool temperature will be maintained even when you scheduled your pump to be off. It does this by turning your pool pump on every 30 minutes and briefly running it long enough to clear the plumbing lines and check the temperature. If the water is still warm, the pump is shut off. If the pool water is more than 1.5° F below set-point, the pool pump will continue to run and your Heat Siphon will turn on and run until the pool reaches temperature. Then both Heat Siphon and pump will shut off.

NOTE: To enable PumpJump™ just PRESS BOTH KEYS once and the blue LED will light indicating it is in PumpJump™. Repeat keypress to disable it.

J-POD PUMP TIME CLOCK OVERRIDE

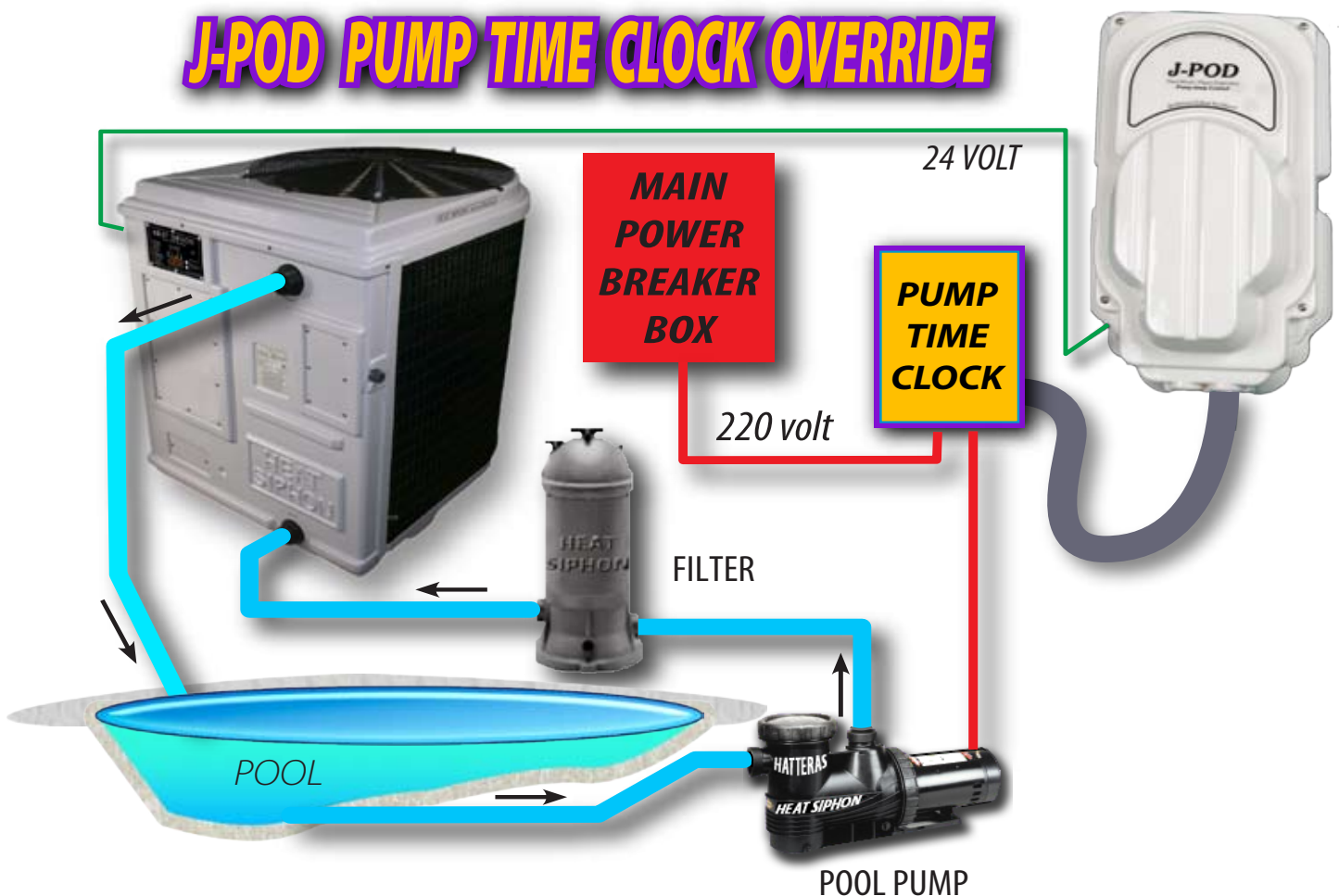

Installing Your 220v J-POD Kit

Hard-wired PumpJump™ on Your D/DX Series Digital HEAT SIPHON®



Installing your J-POD PumpJump kit is EASY however we recommend that you contract a licensed Electrician for the electric power wiring.

The following instructions apply to systems which have an Intermatic™ type pump time clock or equivalent with a basic metal case containing 1/2" conduit knockouts. If your time clock case differs your electrician may need to adapt the power wiring connection to fit your style of case.

CAUTION: BEFORE YOU BEGIN MAKE SURE ALL POWER IS OFF TO YOUR PUMP TIMER AND HEAT SIPHON.

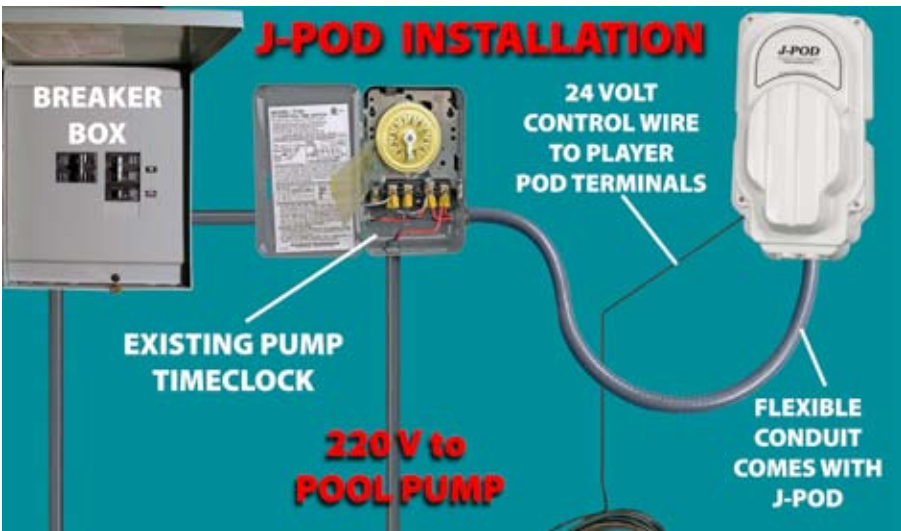

PREFERRED LOCATION:
on a flat wood surface next to your pool pump time clock so that the attached six foot long 1/2" liquid tight flexible conduit will reach the time clock knockout hole. The location should also be within 8-10 feet of Heat Siphon Player Control so the supplied 24 volt sheathed cable will reach it.

QUICK-INSTALL:

CONNECT J-POD to TIME-CLOCK - Punch out a 1/2" knock-out plug in your pump time clock case for the

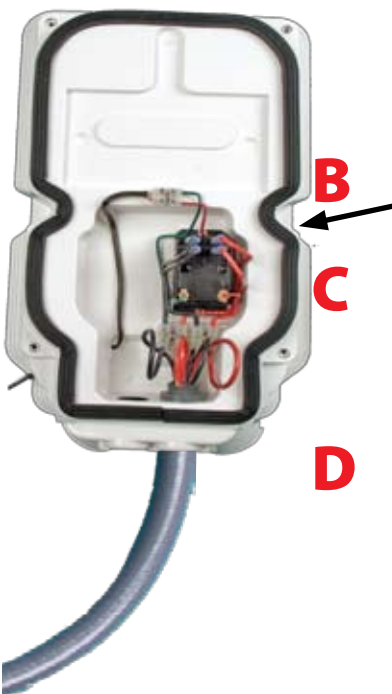

J-POD flexible conduit fitting. Remove the conduit nut and insert the J-POD wires and the liquid-tight connector thru the hole. Fasten the connector using the conduit nut.

MOUNT J-POD - Remove the J-POD case cover. Using the two screw holes in the middle of the J-POD base, mount your J-POD on a wall. Replace the cover.

WIRE J-POD to TIME-CLOCK - Your time clock may vary but the clock contacts will open or close two sets of terminals, there will be two LINE and two LOAD TERMINALS. Connect the RED wires from the J-POD across the RIGHT set of contacts and the BLACK across the LEFT. SEE FIGURE 1.

Run the attached 24 volt control wire to Your Heat Siphon and screw down the pre-stripped leads into the POD terminals on your Player Board. SEE THE ILLUSTRATIONS BELOW SHOWING PLAYER DOOR REMOVAL.

Installing Your 220v J-POD Kit

Hard-wired PumpJump™ on Your D/DX Series Digital HEAT SIPHON®



Detailed Installation Instructions

PART A - Mounting your J-POD

Tools Required:

Cordless Drill
Phillips Head Screw Driver

1 CHOOSE LOCATION - Your J-POD comes PRE WIRED with a six foot flexible conduit attached and ring terminals on the power wires to be connected to your pump time-clock. You will need free wall space approximately 12 inches wide by 24 inches high to mount the J-POD. It should be located beside your Pump Time-clock on the side where you plan to remove the 1/2" knockout plug for connection of the J-POD conduit. Choose a wall mounting location to mount the J-POD so the pump time-clock is within the reach of the six foot flexible conduit and within 8-10 feet of your Heat Siphon if possible (the 24 volt control wire can be extended as necessary).

2 CONNECT J-POD FLEX CONDUIT TO TIME-CLOCK - Punch out the 1/2" knockout you chose for insertion of the J-POD conduit. Remove the locknut from the end of the J-POD conduit and feed the 4 wires thru the knockout hole. Put the wires thru the locknut and tighten it to the J-POD fitting to secure the conduit. Leave the wires free in the Time-clock.

3 MOUNT J-POD - Remove the J-POD cover from the base and fasten the base to the wall using the TWO (2) mounting holes in the center sides of the base. Use appropriate fasteners for the wall material - deck screws if wood or concrete anchor screws etc.

PART B

Power Wiring

DO NOT ATTEMPT POWER WIRING YOURSELF - ONLY a Licensed Electrician should perform all Power Wiring

LOOSEN THE TIME-CLOCK SCREW TERMINALS numbered 1 THRU 4 . Connect the FOUR wires from the J-POD to the FOUR screw down terminals as shown in FIGURE 1.

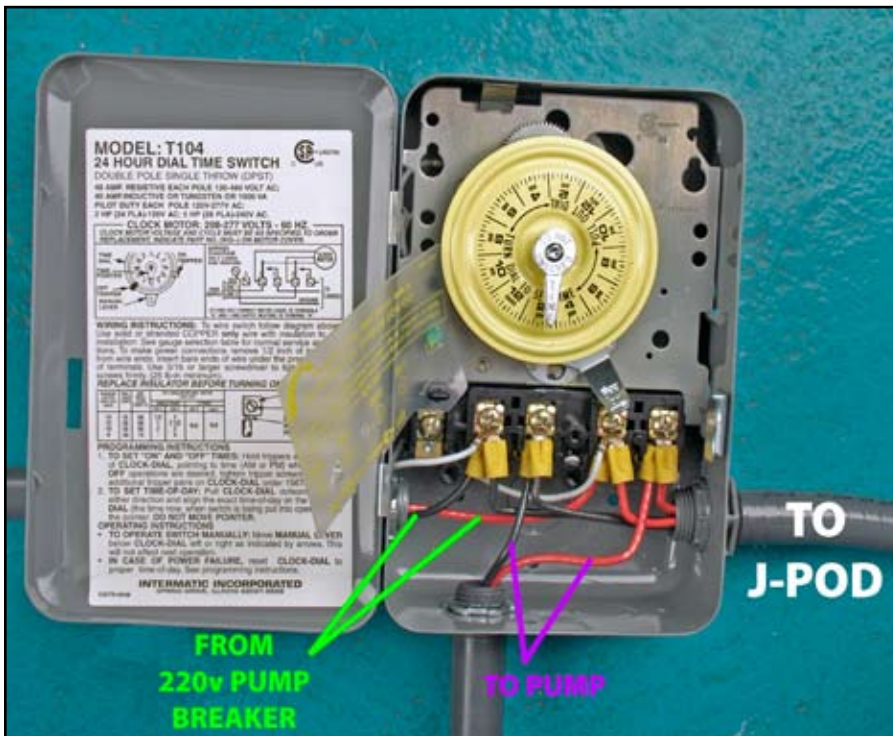

FIGURE 1 J-POD POWER WIRING CONNECTIONS

Installing Your 220v J-POD Kit

Hard-wired PumpJump™ on Your D/DX Series Digital HEAT SIPHON®



Connect the two BLACK POWER wires from the J-POD to the two screw down terminals (1) and (2) ON THE LEFT SIDE time-clock.

Connect the two RED POWER wires from the J-POD to the two screw down terminals (3) and (4) ON THE RIGHT SIDE time-clock.

CAUTION: If the wrong terminals are used your J-POD will SHORT CIRCUIT AND TRIP THE BREAKER

PART C - Heat Siphon Control Wiring

Tools Required:

Small Flat Blade Screw Driver

Phillips Head Screw Driver

Remove Screws and tilt door forward **1**

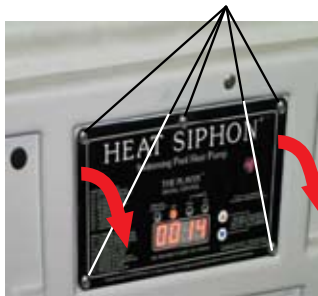

TURN OFF ALL POWER to your Heat Siphon (circuit breaker) and remove the 5 digital door screws. Tilt the door forward until you can access the back of the Player board.

Remove the Heat Siphon fan grille by removing the three stainless steel 3/8"-18 acorn nuts and lifting the grille off the studs. This allows access to the back inside of the Player pocket from above.



ACCESS HOLE FOR CONTROL WIRE



3

Run the brown sheathed control wire from the J-POD to your Heat Siphon and thread it through the access hole (after removing the plastic cap) and through the rubber grommet into the 3/4 inch diameter hole in the Player pocket from behind the backpanel.



Replace the cork tape on the wires and loom coming out of the backside hole or if no tape exists use duct tape to reseal the wires from the inside. This is necessary so that rain blades horizontally will be prevented from

water flung from the fan getting into the Player pocket. NOTE: Later digital models have a wire harness instead of loom and grommet and a separate hole must be drilled for the J-POD cable.

5

Loosen the set screw on the two POD terminals on the Player board. Insert the red and white wires into the POD terminals and screw down the set screws. Pull on the wires to make sure they are securely fastened to the Player board.

TOP OF PLAYER DOOR

POD TERMINALS

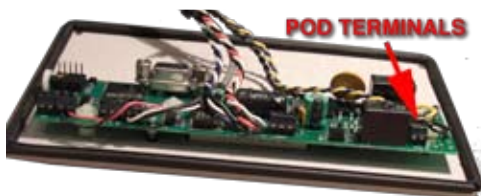

Replace the Player door and 5 screws and fan grille and three acorn nuts.



Installing Your 220v J-POD Kit

Hard-wired PumpJump™ on Your D/DX Series Digital HEAT SIPHON®



Troubleshooting

- ★ **When PumpJump is energized the pump breaker trips**
 - ✘ Incorrectly wired to J-POD
 - two of the wires are crossed (red and black) creating a dead short
 - Check the wiring and rewire
- ★ **You can't access PumpJump**
 - Shutoff breaker to Heat Siphon and wait 30 seconds
 - Restore power by turning Heat Siphon breaker back on
 - Press both keys when temperature is displayed

There are TWO versions of the J-POD both require single phase power - one for 110 volts and one for 220 volt. The following are their installation wiring diagrams:

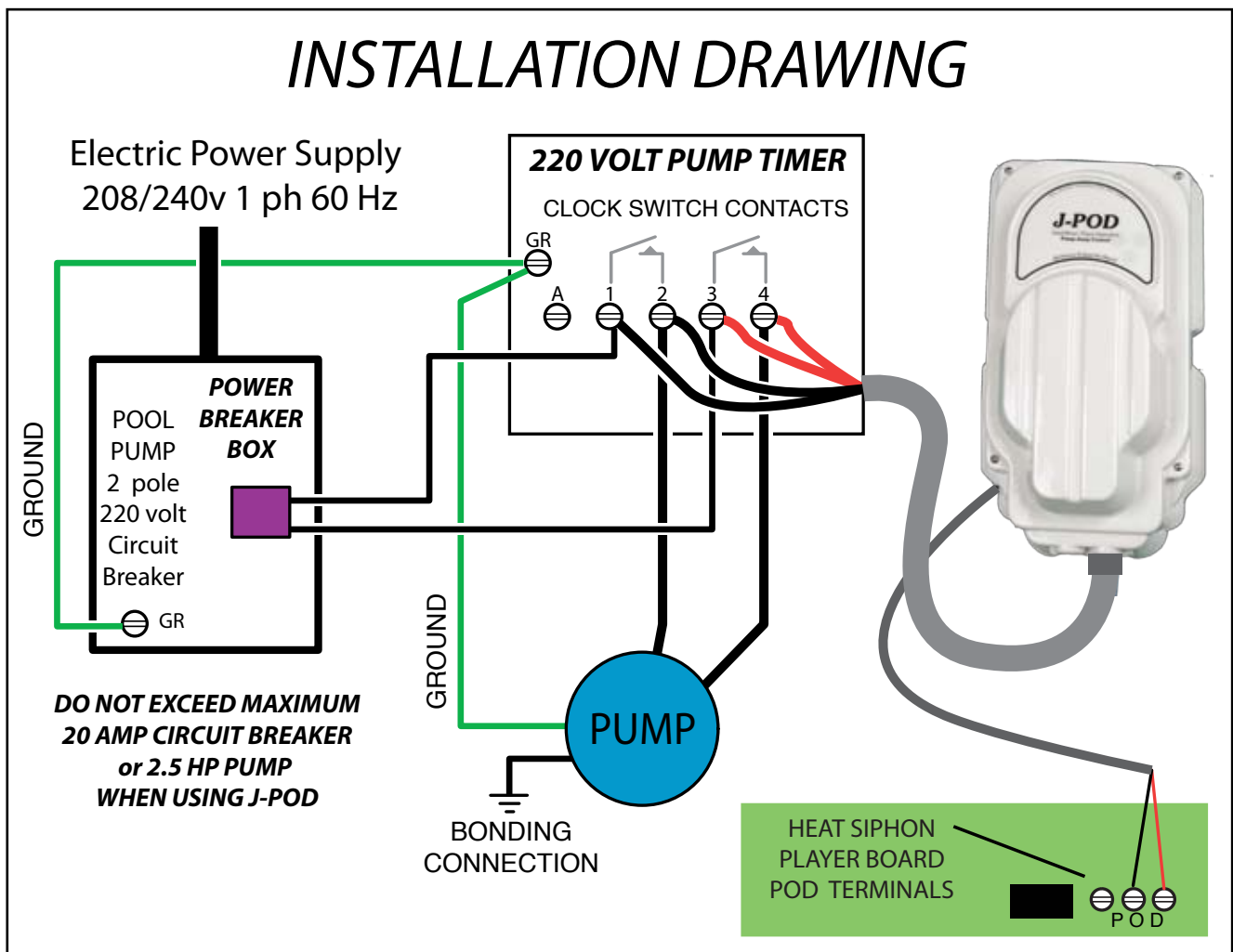

Installing Your 220v J-POD Kit

Hard-wired PumpJump™ on Your D/DX Series Digital HEAT SIPHON®



INSTALLATION DRAWING

